



VOLVO XC60

LISTA DE PREȚURI 2012.V3.14 NOI 2011



VERSIUNILE VOLVO XC60

VOLVO XC60	Putere	Cutie Viteze	Pret Euro fara TVA	Pret Euro cu TVA
KINETIC				
Diesel				
DRIVe (Start-Stop)	163	MT6	28,200	34,968
D3	163	AT6	30,000	37,200
D3 AWD (Start-Stop)	163	MT6	30,900	38,316
D3 AWD	163	AT6	32,700	40,548
D5 AWD (Start-Stop)	215	MT6	33,200	41,168
D5 AWD	215	AT6	35,000	43,400
Benzina				
T5	240	PS6	31,500	39,060
3.2 AWD	243	AT6	34,900	43,276
T6 AWD	304	AT6	37,100	46,004

	Pret Euro fara TVA	Pret Euro cu TVA
XC60 RDESIGN (cod 998916)	3,600	4,464
Suplimentar fata de Standard	<i>Sasiu sport Rdesign Volan sport Rdesign Schimbator de viteze Rdesign Pedale sport Rdesign Ornamente interioare Rdesign Covorase textile Rdesign Tapiterie piele sport Rdesign Instrumente de bord watch dial Rdesign Grila fata Rdesign (emblema Rdesign) Ornamente argintii Rdesign - fata/lateral praguri Capace oglinzi exterioare satinat Scut ornamental spate Rdesign, argintiu (skid-plate) 2 tevi esapament (stanga/dreapta) sport, Rdesign Jante alianj Rdesign - 18" jante aliaj, CRATUS, 235/60 R18 - Anvelope Pirelli</i>	

	Pret Euro fara TVA	Reducere fara TVA	Pret redus fara TVA	Pret Euro cu TVA
XC60 MOMENTUM	2,724	724	2,000	2,480
Suplimentar fata de Standard	<i>Senzor de parcare cu avertizare sonora pentru mersul inapoi Instrumente de tip Watch Dial / Manechin ECC cromat Ornamente geamuri "bright décor" Oglinda retrovizoare cu efect heliomat Haion electric Tapiterie ERIKSBERG, Textile / Tricottech Volan 4 spate imbracat in piele cu ornamente satinat Sistem audio High Performance, 8 difuzoare, 4x40W, Radio/CD/MP3-WMA/AUX/USB/Bluetooth/Ecran color 5"</i>			

	Pret Euro fara TVA	Reducere fara TVA	Pret redus fara TVA	Pret Euro cu TVA
XC60 SUMMUM	6,542	1,842	4,700	5,828
Suplimentar fata de Standard	<i>Scaun sofer cu reglaj electric si memorie scaun/oglinzi ext. Bare longitudinale argintii Senzor de umiditate Tapiterie Piele Faruri Bi-Xenon adaptive / Spalator faruri 18" jante aliaj, ZEPHYRUS, 235/60 R18 (Pirelli)</i>			

PACHETE OPTIONALE VOLVO XC60

COD		Pret Euro fara TVA	Reducere fara TVA	Pret redus fara TVA	Pret Euro cu TVA	Kinetic	Rdesign	Momentum	Summum
SP	PACHET SECURITY	1,397	347	1,050	1,302	0	0	0	0
236	Geamuri laterale anti fractie (fata / spate) tratate hidrofug (fata)								
140	Alarma Volvo cu telecomanda, senzor de inclinare / miscare								
583	Sistem keyless + Personal Car Communicator								
DS	*PACHET DRIVER SUPPORT	3,073	956	2,117	2,625	0	0	-	-
		2,743	956	1,787	2,216	-	-	0	0
167	Oglinzi exterioare rabatabile electric cu lumini incorporate								
370	Senzor de ploaie								
818	Sistem avertizare coliziune frontala cu FULL AUTOBRAKE si Pedestrian Detection - ACC si CWAB (include pilot automat adaptiv/ include functie Stop&Go in combinatie cu transmisia automata)								
603	BLIS								
769	Sistem avertizare sofer - Driver Alert (nu cu cod 386)								
*) nu impreuna cu 319,386,33									
DD	*PACHET DRIVING DYNAMICS	1,609	483	1,126	1,396	0	-	0	0
533	4C - Sistem suspensie adaptiva (nu cu 21sau 575; doar cu 316 sau 437sau 762 pe SV32)								
171	Servodirectie ajustabila la viteza								
*) nu impreuna cu 21,Rdesign, ornamente standard									
FP	*PACHET FAMILY			203	252	0	0	0	0
322	Scaune pentru copii integrate in bancheta spate, stanga/dreapta, 2 trepte de inaltime (nu cu cod 752)								
114	Siguranta electrica pentru copii la usile din spate								
*) nu impreuna cu 752									
WINPACK	PACHET WINTER	584	144	440	546	0	0	0	-
11	Scaune fata incalzite								
65	Sistem spalare faruri								
ABLPACK	PACHET WINTER ABL	1,431	432	999	1,239	0	0	0	-
11	Scaune fata incalzite								
605 / 65	Faruri Adaptive Bi-Xenon inclusiv sistem de spalare (65)								
XENPACK	PACHET XENIUM	4,827	1,448	3,379	4,190	-	-	-	0
10	Scaun pasager cu reglaj electric (numai cu cod 47, numai cu 167)								
11	Scaune fata incalzite								
30	Trapa (panoramica)								
142	Sistem de navigatie (RTI)								
691	Senzor parcare cu avertizare sonora la mersul fata/spate (nu cu 529)								
790	Camera pentru asistare parcare spate (numai impreuna cu 142/522)								
831	High Performance Multimedia, 8 difuzoare, 4x40W, Radio/DVD/MP3/AUX/USB/Bluetooth/Ecran color 7"								
BUSPACK	PACHET BUSINESS	2,109	636	1,473	1,827	-	-	0	0
142	Sistem de navigatie (RTI)								
831	High Performance Multimedia, 8 difuzoare, 4x40W, Radio/DVD/MP3/AUX/USB/Bluetooth/Ecran color 7"								
PROPACK	PACHET BUSINESS PRO	3,015	907	2,108	2,614	0	0	-	-
142	Sistem de navigatie (RTI)								
831	High Performance Multimedia, 8 difuzoare, 4x40W, Radio/DVD/MP3/AUX/USB/Bluetooth/Ecran color 7"								
529	Senzor de parcare cu avertizare sonora pentru mersul inapoi (nu cu 691)								
CONPACK	PACHET CONFORT RDESIGN	1,821	458	1,363	1,690	-	0	-	-
115	Haion electric								
167	Oglinzi exterioare rabatabile electric cu lumini incorporate								
168	Oglinda retrovizoare cu efect heliomat								
370	Senzor de ploaie								
832	High Performance, 8 difuzoare, 4x40W, Radio/CD/MP3/AUX/USB/Bluetooth/Ecran color 5"								
529	Senzor de parcare cu avertizare sonora pentru mersul inapoi (nu cu 691)								
COMBPACK	PACHET CONFORT II RDESIGN	3,929	1,541	2,388	2,961	-	0	-	-
115	Haion electric								
167	Oglinzi exterioare rabatabile electric cu lumini incorporate								
168	Oglinda retrovizoare cu efect heliomat								
370	Senzor de ploaie								
529	Senzor de parcare cu avertizare sonora pentru mersul inapoi (nu cu 691)								
142	Sistem de navigatie (RTI)								
831	High Performance Multimedia, 8 difuzoare, 4x40W, Radio/DVD/MP3/AUX/USB/Bluetooth/Ecran color 7"								

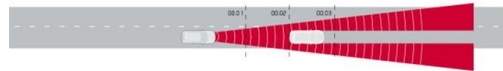

DOTARI OPTIONALE VOLVO XC60

COD		Pret Euro fara TVA	Pret Euro cu TVA	Kinetic (SV11)	RDesign (SVR1)	Momentum(SV12;	Summum(SV13)
EXTERIOR							
30	Trapa (panoramica)	1,135	1,407	0	0	0	0
115	Haion electric	423	525	0	0	0	0
605 / 65	Faruri Adaptive Bi-Xenon inclusiv sistem de spalare	1,126	1,396	0	0	0	0
65	Sistem de spalare faruri sub presiune	279	346	0	0	0	0
179	Geamuri spate fumurii	330	409	0	0	0	0
236/595	Geamuri laterale antiefractie (fata/spate) tratate hidrofug (fata)	474	588	0	0	0	0
595	Geamuri laterale fata tratate hidrofug (inclus in 236/595)	93	115	0	0	0	0
386	IR - parbriz reflectorizant (doar cu 370)	237	294	0	0	0	0
168	Oglinda retrovizoare cu efect heliomat	161	200	0	0	0	0
454	Oglinda retrovizoare cu efect heliomat, cu busola (include 168)	220	273	0	0	0	0
		59	73	-	-	-	-
370	Senzor de ploaie	93	115	0	0	0	0
671	Lumini aprinse permanent	0	0	0	0	0	0
167	Oglinzi exterioare rabatabile electric cu lumini incorporate	237	294	0	0	0	0
308	Fara emblema motorizare (nu pentru DRIVE)	0	0	0	0	0	0
273	Preincalzitor cu temporizare (scoate std.PTC)	999	1,239	0	0	0	0
529	Senzor de parcare cu avertizare sonora pentru mersul inapoi (nu cu 691)	390	484	0	0	0	0
691	Senzor parcare cu avertizare sonora la mersul fata/spate (nu cu 529)	627	777	0	0	-	-
		237	294	-	-	0	0
INTERIOR							
439	AQS - sistem control calitate aer	0	0	0	0	0	0
727	Senzor de umiditate	42	52	0	0	0	0
47	Scaun sofer cu reglaj electric si memorie scaun/oglinzi ext.	618	766	0	0	0	0
10	Scaun pasager cu reglaj electric (numai cu cod 47, numai cu 167)	381	472	0	0	0	0
11	Scaune fata incalzite	305	378	0	0	0	0
322	Scaune pentru copii integrate in bancheta spate, stanga/dreapta, 2 trepte de inaltime (nu cu cod 752)	194	241	0	0	0	0
752	Scaune spate incalzite (nu cu 322 ; obligatoriu cu 11)	305	378	0	0	0	0
319	Volan din lemn (numai impreuna cu 316)	364	451	0	-	0	0
334	Schimbator de viteze piele / lemn "Classic" (numai transmisie geartronic; nu cu 333,762,RDesign)	93	115	0	-	0	0
575	Ornamente standard tip Charcoal (negre) - nu cu 437,316,762,533,Rdesign	0	0	0	-	0	0
437	Ornamente interioare aluminiu pe panouri usi / consola (nu cu 575,316,762,RDesign)	279	346	0	-	0	0
316	Ornamente de lemn "Classic" (consola) - nu cu 575,437,762,RDesign	703	872	0	-	-	-
		423	525	-	-	0	0
762	Ornamente interioare lemn „Laminated Oak” (nu cu cod 316,319,334,437,575,RDesign)	703	872	0	-	-	-
		423	525	-	-	0	0
817	Volan, suprafete inferioare bord si schimbator viteze in culoare beige (numai cu tapiterii beige -G012,G112,G116,G612 ;nu cu RDesign)	0	0	0	-	0	0
289	Suport ochelari	17	21	0	0	0	0
390	Tetiere rabatabile electric	119	148	0	0	0	0
346	Suport cumparaturi in portbagaj	85	105	0	0	0	0
AUDIO							
832	High Performance, 8 difuzoare, 4x40W,Radio/CD/MP3/AUX/USB/Bluetooth/Ecran color 5"	517	641	0	0	0	0
831	High Performance Multimedia, 8 difuzoare, 4x40W,Radio/DVD/MP3/AUX/USB/Bluetooth/Ecran color 7"	999	1,239	0	0	-	-
		483	599	-	-	0	0
830	Premium Sound Multimedia Dolby ProLogic II & Dolby ProLogic 5.0 Cinema Edition, 12 difuzoare, 5x130W,Radio/DVD/MP3/AUX/USB/Bluetooth/Ecran color 7"	1,465	1,817	0	0	-	-
		948	1,176	-	-	0	0
262	Subwoofer (numai cu 830)	195	242	0	0	0	0
142	Sistem de navigatie (RTI) (obligatoriu cu 235,33 sau 818 ; obligatoriu cu 830 sau 831)	1,626	2,016	0	0	0	0
		0	0	-	-	-	-
833/860	Digital TV cu telecomanda - numai impreuna cu 830 sau 831	915	1,135	0	0	0	0
834/860	DVD in tetierele scaunelor spate (Rear Seat Entertainment) - obligatoriu cu 830 sau 831	1,592	1,974	0	0	0	0
860	Telecomanda multimedia (numai impreuna cu 830 sau 831)	0	0	0	0	0	0
509	Mufa casti pentru locuri spate (numai cu 830,831 sau 832 ; scoate din std.scrumiera spate)	119	148	0	0	0	0
445	Pregatire pentru sistem de navigatie (RTI) - numai impreuna cu 830/831/832	25	31	0	0	0	0
SASIU							
533	4C - Sistem suspensie adaptiva (nu cu 21/575/RDesign; doar cu 316/437/762 pe SV32)	1,423	1,765	0	-	0	0
153	Sasiu Touring (confort)- scoate din standard sasiul dinamic	0	0	0	-	0	0
21	Nivomat, sistem de mentinere constanta a garzii la sol (nu cu cod 533/RDesign)	474	588	0	-	0	0
171	Servodirectie ajustabila la viteza (nu cu Rdesign)	186	231	0	-	0	0
SIGURANTA							
140	Alarma Volvo cu telecomanda, senzor de inclinare / miscare	263	326	0	0	0	0
583	Sistem keyless + Personal Car Communicator (doar impreuna cu 140- alarma)	660	818	0	0	0	0
790	Camera pentru asistare parcare spate (numai impreuna cu 830/831)	660	818	0	0	0	0
769	Sistem avertizare sofer - Driver Alert (nu cu 386, numai cu 370)	660	818	0	0	0	0
818	Sistem avertizare coliziune frontala cu FULL AUTOBRAKE si Pedestrian Detection - ACC si CWAB (include pilot automat adaptiv/ include functie Stop&Go in combinatie cu transmisia automata) (nu cu volan standard, nu cu 386; doar impreuna cu 370/235)	1,609	1,995	0	0	0	0
603	BLIS (obligatoriu cu cod 167)	474	588	0	0	0	0
372	HomeLink EU	68	84	0	0	0	0

DOTARI OPTIONALE VOLVO XC60

COD		Pret Euro fara TVA	Pret Euro cu TVA	Kinetic	Rdesign	Momentum	Summum
CULORI EXTERIOARE							
19	Black Stone solid (nu cu Rdesign)	0	0	0	-	0	0
614	Ice White solid	0	0	0	0	0	0
612	Passion Red solid (numai impreuna cu Rdesign)	0	0	-	S	-	-
426	Silver metallic (nu cu Rdesign)	754	935	0	-	0	0
452	Black Sapphire metallic	754	935	0	0	0	0
481	Cosmic White Metallic	754	935	0	0	0	0
484	Seashell Metallic	754	935	0	-	0	0
492	Savile Grey pearl	754	935	0	0	0	0
494	Terra Bronze pearl	754	935	0	0	0	0
498	Caspian Blue	754	935	0	-	0	0
702	Flamenco Red	754	935	0	-	0	0
477	Electric Silver	931	1,154	0	0	0	0

Black Stone Solid



Ice White Solid



Silver metallic



Black Sapphire metallic



Seashell Metallic



Cosmic White metallic



Electric Silver



Passion Red



Savile Grey pearl



Terra Bronze pearl



Flamenco Red



Caspian Blue



JANTE

840	18" jante aliaj, ZEPHYRUS, 235/60 R18 - Anvelope Pirelli	855	1,060	0	-	0	S
824	18" jante aliaj, MERAC, 235/60 R18 - Anvelope Pirelli	855	1,060	0	-	0	-
		0	0	-	-	-	0
	18" jante aliaj, CRATUS - numai pentru Rdesign	0	0	-	S	-	-
699	19" jante aliaj, FENRIR, 235/55 R19	1,219	1,512	0	-	0	-
		364	451	-	-	-	0
800039	20" jante aliaj, CRATUS - numai pentru Rdesign	762	945	-	0	-	-
312	Antifurt jante aliaj	34	42	0	0	0	0

SEGIN



ZEPHYRUS

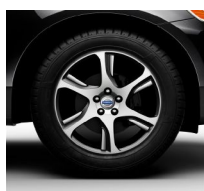

MERAC



CRATUS



FENRIR













DOTARI OPTIONALE VOLVO XC60

TAPITERII	Pret Euro fara TVA	Pret Euro cu TVA	Kinetic	Rdesign	Momentum	Summum
Tapiterie Textil Lomma	0	0	S	-	-	-
Tapiterie Textil/Tricotech Eriksberg	339	420	O	-	S	-
Tapiterie Piele	1516	1,880	O	-	-	-
	1177	1,459	-	-	O	S
Tapiterie Piele Rdesign (numai in pachet Rdesign)	0	0	-	S	-	-









COD	DENUMIRE TAPITERIE	Culoare Interior	Culoare tapiterie	Culoare panou superior bord /panou usa	Culoare insertii usa	Culoare covorase	Culoare plafon
TAPITERIE TEXTIL LOMMA							
G000	Off Black/Off Black	Negru	Negru	Negru/Negru	Negru	Negru	Bej
TAPITERIE TEXTIL ERIKSBERG							
G600	Off Black/Off Black	Negru	Negru	Negru/Negru	Negru	Negru	Bej
G612	Sandstone Beige/Beige	Bej	Bej	Maro/Bej	Bej	Maro	Bej
TAPITERIE PIELE							
G100	Off Black/Off Black	Negru	Negru	Negru/Negru	Negru	Negru	Bej
G112	Sandstone Beige/Beige	Bej	Bej	Maro/Bej	Bej	Maro	Bej
G10B	Sandstone Beige/Off Black	Bej	Bej	Negru/Negru	Bej	Negru	Bej
G116	Sandstone Beige-Espresso Brown/Espresso	Bej	Maro/Bej	Maro/Bej	Maro	Maro	Bej
TAPITERIE PIELE RDESIGN							
GM00	Off Black/Off Black/ Soft Beige Sandstone Beige/Soft Beige/Off	Negru	Negru cu insertii bej	Negru/Negru	Negru	Negru	Bej
GM02	Black	Bej	Bej cu insertii negre	Maro/Bej	Bej	Maro	Bej
GM0U	Off Black/Off Black	Negru	Negru	Negru/Negru	Negru	Negru	Bej

ACCESORII VOLVO XC60

COD	EXTERIOR	Pret Euro fara TVA	Pret Euro cu TVA
	Praguri iluminate (usi fata/spate) - set de 4buc.si harnasament cabluri	788	977
	Ornamente exterioare praguri - set de 2buc.	579	718
	Praguri exterioare - kit complet de 2 praguri	1,400	1,736
	Ornament spoiler fata	398	493
	Ornament spoiler spate	414	513
	Carlig remorcare demontabil (include mod trailer,cablaj si software)	781	969
	Bare transversale demontabile (necesita optiune bare longitudinale) · set2buc.	148	183
	Suport ski (1 pereche skiuri)	124	154
	Cutie plafon Weekender	413	512
	Cutie plafon Space Design 2000 Anthracite	679	842
	Cutie plafon Space Design 2300 Anthracite	1,000	1,240

ACCESORII VOLVO XC60

COD		Pret Euro fara TVA	Pret Euro cu TVA
EXTERIOR			
	Husa protectie masina (cablu de sigurantare inclus)	329	408
	Jante aliaj 19" ACHILLES Diamond Cut, 235/55 R19 (set 4buc.si kit montaj)	3,617	4,485
	Jante aliaj 19" ERAKIR Diamond Cut/Silver Stone, 235/55 R19 (set 4buc.si kit montaj)	2,809	3,483
	Jante Thalita Diamond Cut/Silverstone+anvelope 255/45R20 105V XL Pirelli Scorpion Zero Asimmetrico (set4buc.)	3,571	4,849
	Jante Thalita Diamond Cut/Dark Grey+anvelope 255/45R20 105V XL Pirelli Scorpion Zero Asimmetrico (set4buc.)	3,095	4,202
INTERIOR			
	Sistem de navigatie portabila Volvo (receptor de trafic inclus)	876	1,086
	DVD in tetierele scaunelor spate (Rear Seat Entertainment) - set 2 casti/2 telecomenzi	2,849	3,533
	Scaun copil (9-25kg)	513	636
	Husa protectie bara spate (portbagaj)	70	87
	Covorase interioare de cauciuc (set 4 buc.)	97	120
	Perna scaun	44	54
	Cutie electrica portbagaj racire/incalzire (include cutie,kit montaj si transformator 24V)	374	464

ECHIPAMENT STANDARD VOLVO XC60

SIGURANTA

ABS

EBD – Distributie electronica a fortei de franare
EBL – Stopuri frana cu functie de panica
DSTC - Sistem dinamic control tractiune si stabilitate
EBA - Asistare la franarea de urgenta
WHIPS - Protectie impact din spate pentru scaune fata
Airbaguri fata sofer si pasager
SIPS bags , airbag-uri laterale
IC - Airbag-uri tip cortina
IDIS – Sistem inteligent gestionare informatii sofer
RSC - Sistem de control la rasturnare
HDC - Asistent la coborare/urcare pe suprafete inclinate (nu T5/DRIVE/D3FWD)
CITY SAFETY - sistem de evitare a coliziunilor la viteze mici (generatie 2)
Pretensionare pirotehnica centuri siguranta cu blocare automata
Lumini ceata spate cu functie auto-off
Inchidere centralizata cu telecomanda; Inchidere de siguranta
Imobilizator electronic la pornire
Lumini "Home safe"
"Pacos" - Comutator anulare airbag pasager
Frana de parcare electrica cu functie "drive-release"
ISOFIX

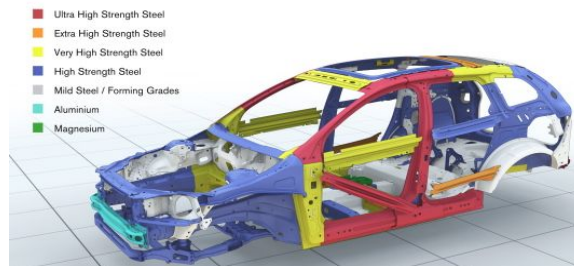

EXTERIOR

JANTE, SASIU, TRANSMISIE, CUTIE DE VITEZE

17" jante aliaj, SGIN, 235/65 R17 (anvelope Continental)
Tevi esapament duble (stanga/dreapta) - nu pentru DRIVE/D3FWD
Sasiu dinamic
Servodirectie hidraulica
Tractiune integrala controlata electronic (nu pentru T5/DRIVE/D3FWD)
Cutie de viteze manuala in 6 trepte (DRIVE, D3 AWD, D5 AWD)
Cutie de viteze powershift in 6 trepte (T5)
Cutie de viteze geartronic 6 trepte (D3FWD, D3 AWD, D5 AWD, 3.2AWD, T6AWD)

DESIGN

Ornamente exterioare in culoarea caroseriei (partial)
Lampi DNA Volvo, fata
Bare longitudinale integrate in acoperis (negre)
Oglinzi electrice si incalzite in culoarea caroseriei
Semnalizatoare in oglinzile exterioare
Ornamente exterioare geamuri (negre)
Emblema DRIVE (numai pentru DRIVE)

ALTELE

Filtru de particule diesel (motorizari diesel)
Positive Temperature Control (PTC) (motorizari diesel)
Duze spalator parbriz incalzite

INTERIOR

CONFORT

Tehnologie Start-Stop (numai pentru motorizarile diesel cu cutie manuala)
Climatizare automata
Pilot automat
Volan reglabil pe inaltime si telescopic (coloana deformabila)
Priza 12 V in consola fata/spate
Priza 12V in portbagaj
Scaune fata ajustabile manual
Geamuri electrice fata / spate (automate)
Tetiere spate cu reglaj manual
Cotiera fata cu suport pentru pahare; Scrumiera
Cotiera spate cu suport pentru pahare
Indicator temperatura exterioara
Luneta spate incalzita electric
Spatiu depozitare in usi, consola fata si portbagaj
Computer de bord
Bancheta spate rabatabila (40/20/40)
Prelata portbagaj (soft)
Oglinzi parasolar iluminate (sofer si pasager)



DESIGN

Tapiterie textil LOMMA
Volan 4 spate imbracat in piele (fara ornamente satinat)
Schimbator de viteze imbracat in piele
Instrumente de bord tip Watch Dial (pentru T6AWD/D5AWD)
Tuometru; Ceas digital
Ornamente interioare negre tip Charcoal
Covorase textile (4 buc.)
Plasa protectie bagaje (soft)

AUDIO

Radio CD player 1 disc; Performance 6 difuzoare ; compatibil MP3/WMA
Amplificator 4X20W
Comenzi audio pe volan
Intrare auxiliara jack 3.5"

ALTELE

Display in limba Engleza
Kit reparatie anvelope
Triunghi reflectorizant; Trusa de prim ajutor

SPECIFICATIILE TEHNICE VOLVO XC60

Motorizare	T5	3.2 AWD	T6AWD	*D3 FWD (DRIVE)	*D3 AWD	*D5 AWD	D5 AWD
Norma de poluare	EURO5	EURO5	EURO5	EURO5	EURO5	EURO5	EURO5
Numar cilindri	4	6	6	5	5	5	5
Numar valve	16	24	24	20	20	20	20
Capacitate cilindrica (cmc)	1999	3192	2953	1984	2400	2400	2400
Putere maxima (kw/rpm)	177(240)/5500	179(243)/6400	224 (304) / 5600	120(163) / 3500	120(163) / 4000	158(215) / 4000	158(215) / 4000
Cuplu maxim (Nm/rpm)	320/1800-5000	320/3200	440 / 2100-4200	400 / 1500-2750	420 / 1500-2500	420 / 1500-3250	440 / 1500-3000
Acceleratie (0-100 km/h)	8.1	9.9	7,3	10.3/10.3	10.5/10.9	8.4	8.8
Viteza maxima (km/h)	210	210	210	200/195	195/190	210	205
Consum mediu (l/100km)	8.5	9.9	10.7	5.7/6.8	5.6/6.8	5.6	6.8
Emisii specifice CO2 (g/km)	198	229	249	149/178	149/179	149	179
Transmisie	PS6	AT6	AT6	MT6/AT6	MT6/AT6	MT6	AT6

*) tehnologie Start-Stop pentru transmisilele manuale

Garantie : 24 luni fara limita de km / Garantie anticorozivune : 12 ani

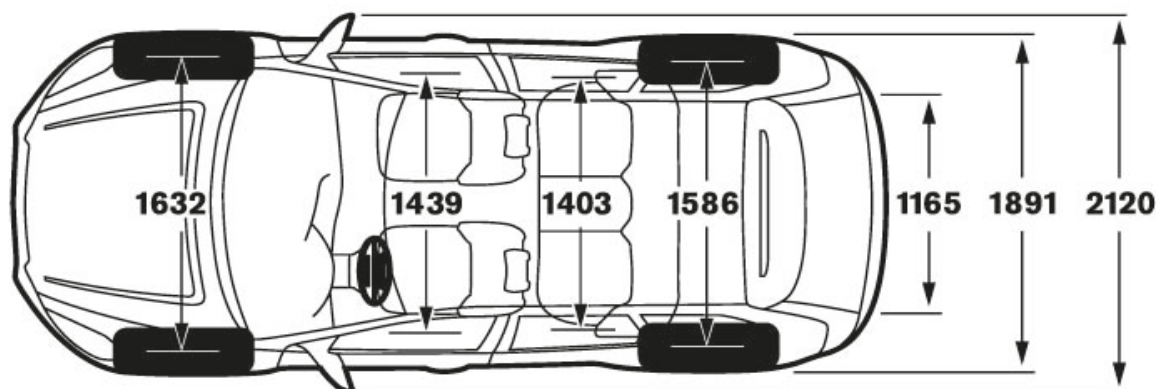
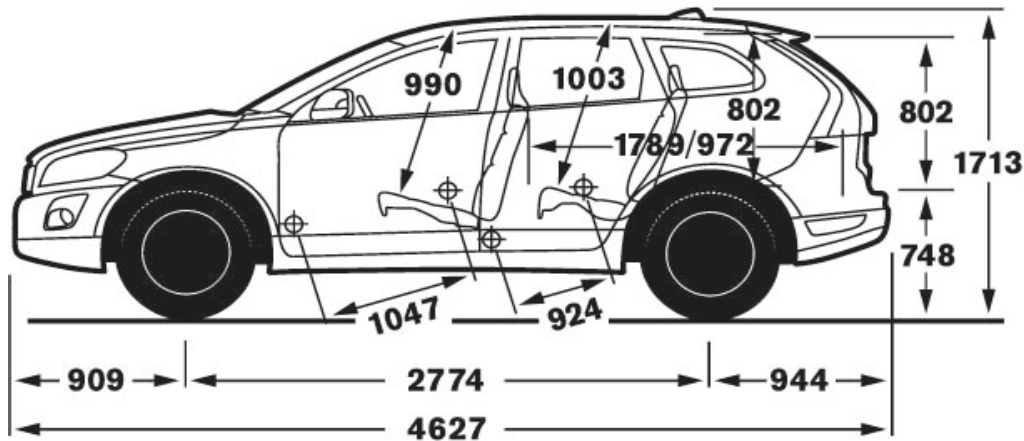

Lista de preturi valabila de la 01.05.2011 .v3.Actualizare 14.11.2011.Producatorul isi rezerva dreptul de a aduce modificari prezentei liste de preturi in ceea ce priveste pretul, paleta de culori, tapiteriile, echipamentul standard si optional, datele tehnice si de a intrerupe fabricarea oricarui model.Preturile se vor calcula in lei la cursul EUR/RON din ziua platii, comunicat de Dealer.